

# WallDamp Standard & Economy

INSTALLATION

## Required Tools:

- Standard Gypsum Wallboard
- Moisture Resistant Wallboard
- Drywall Screws

## Parts Included:

- 4" x 4" Squares
- 1 1/2" x 48" Strips
- Acoustical Sealant

## Working with WallDamp

• Remove release paper from one side of the **WallDamp Strips or Squares**. Apply as recommended over all the joint seams, perimeter of walls and openings and field areas. Leave release paper from the opposite side on until you are ready to install next layer of sheetrock.

• We recommend **WallDamp Squares** be firmly adhered by applying to a clean surface using a rubber mallet. Gently but firmly apply a light tap to the paper covered side of each square after they are in place.

## Basic Procedure

- 1) Apply 1 1/2" WallDamp Strips to entire lengths of all exposed framing surfaces to be treated.
- 2) Peel the release paper from the WallDamp. Attach the first layer of gypsum wallboard (use Moisture Resistant type). Place non-tapered edge side of the wallboard to the interior of the room (reversed). This leaves a consistent flat surface for the 2nd layer of wallboard to adhere. Use standard screw spacing. Leave a 1/4" gap around the entire perimeter of all walls. Do not tape seams or texture this wallboard layer with drywall joint compound.
- 3) Apply a bead of Acoustical Sealant to seal the 1/4" gap around the perimeter.
- 4) Adhere 1 1/2" WallDamp Strips over all the wallboard seams and around the entire perimeter of the walls as shown in the **Layout diagrams**.

## WallDamp Squares



## Acoustic Sealant



## WallDamp Strips



## Drywall Screws



## Standard and Greenboard Drywall

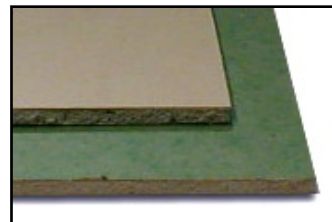

## WallDamp Economy

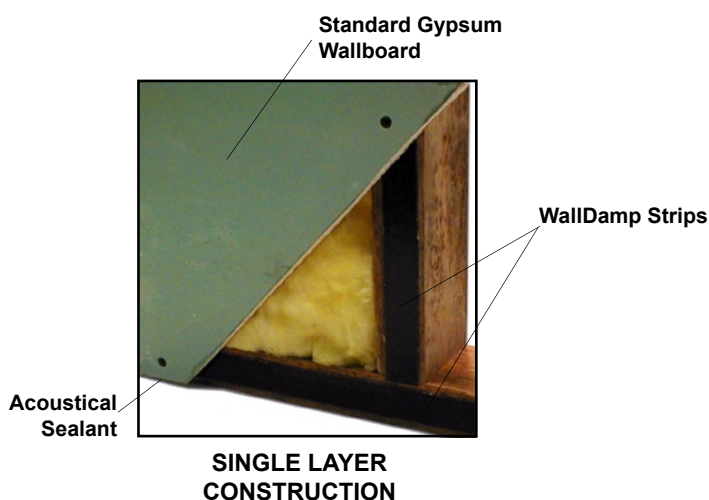

## WallDamp Standard

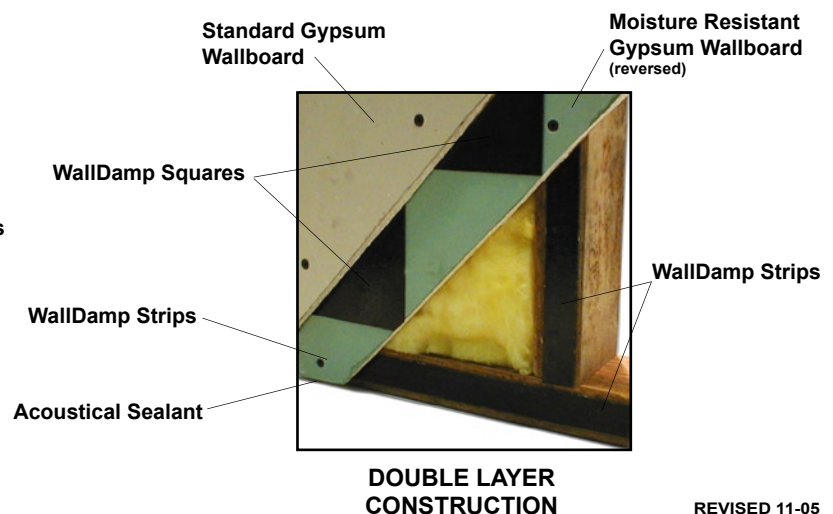

REVISED 11-05

## Basic Procedure (continued)

5) Adhere 4" WallDamp Squares in a grid pattern as shown in the **Layout diagrams**.

6) Peel release paper from the WallDamp. Attach the second layer of standard gypsum wallboard to the framing with the finished side out. Use standard screw spacing. Stagger all the seams so they do not overlap the first wallboard layer seams. Leave a 1/4" gap around the entire perimeter of all walls.

7) Apply a bead of Acoustical Sealant to seal the 1/4" gap around the perimeter.

8) Tape seams with drywall joint compound and finish.

## Concrete Installation

Attach the WallDamp wall to concrete using the same basic procedures outlined above. Instead of studs to support your sheetrock layers, attach 1 x 2 furring strips horizontally to your concrete wall. Spacing should be 16" centers for a standard 8' wall, 12" if your wall is higher. Make sure the furring strips are firmly attached using glue and masonry nails. Once the furring strips are in place, apply WallDamp strips, then go back to step 2 of the Basic Procedure.

## Still Not Sure?

If these instructions appear unclear or beyond your skill level, we highly recommend you hire a skilled professional contractor. You've ordered the best sound treatment products available, we think you should hire the best for the installation too.

## Layout Diagrams

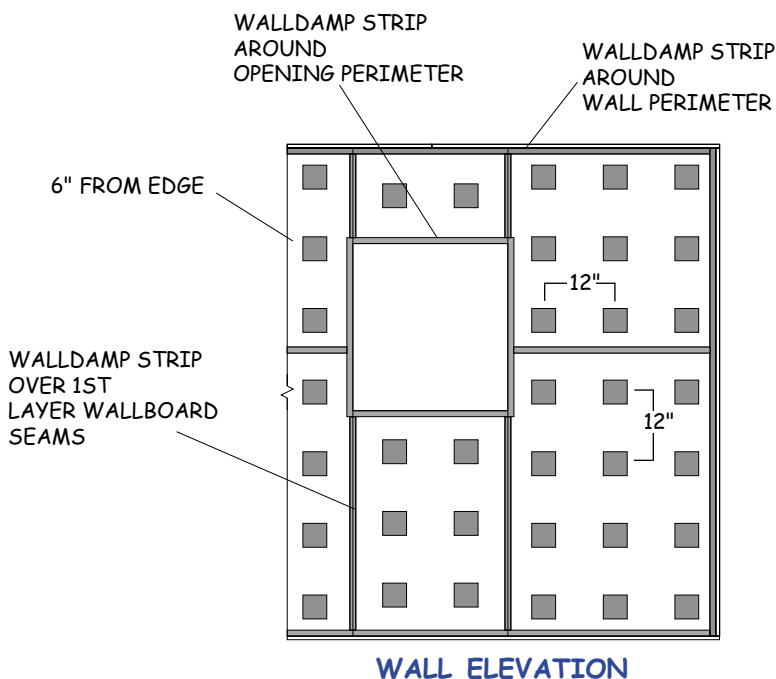

## WallDamp Standard Installation

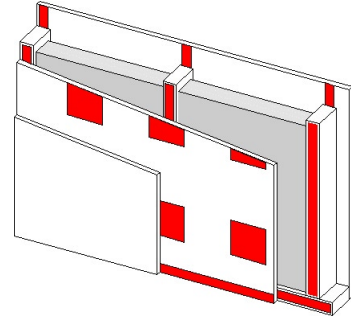

## WallDamp Economy Installation

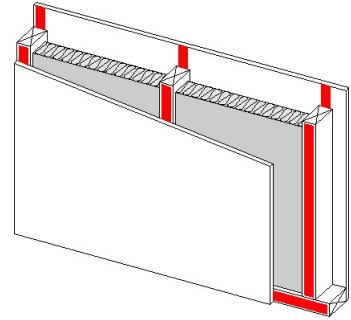

## WallDamp Standard Installation Using Staggered Studs

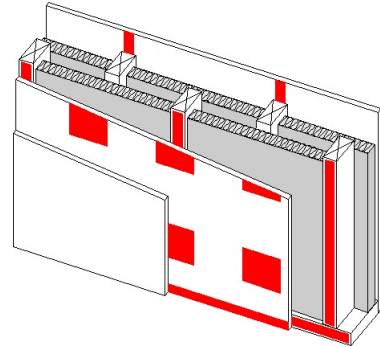

## WallDamp Concrete Installation

